



PATTERN 17959A Los Amigos Wave

Geometric
Part Size: 94.75" W x 36.75"
Max Depth: 0.88"

Vac-U-Form™
Styrene - Single Use.
ABS Plastic - Up to 15 reuses.

Forming The Future™

PANEL A

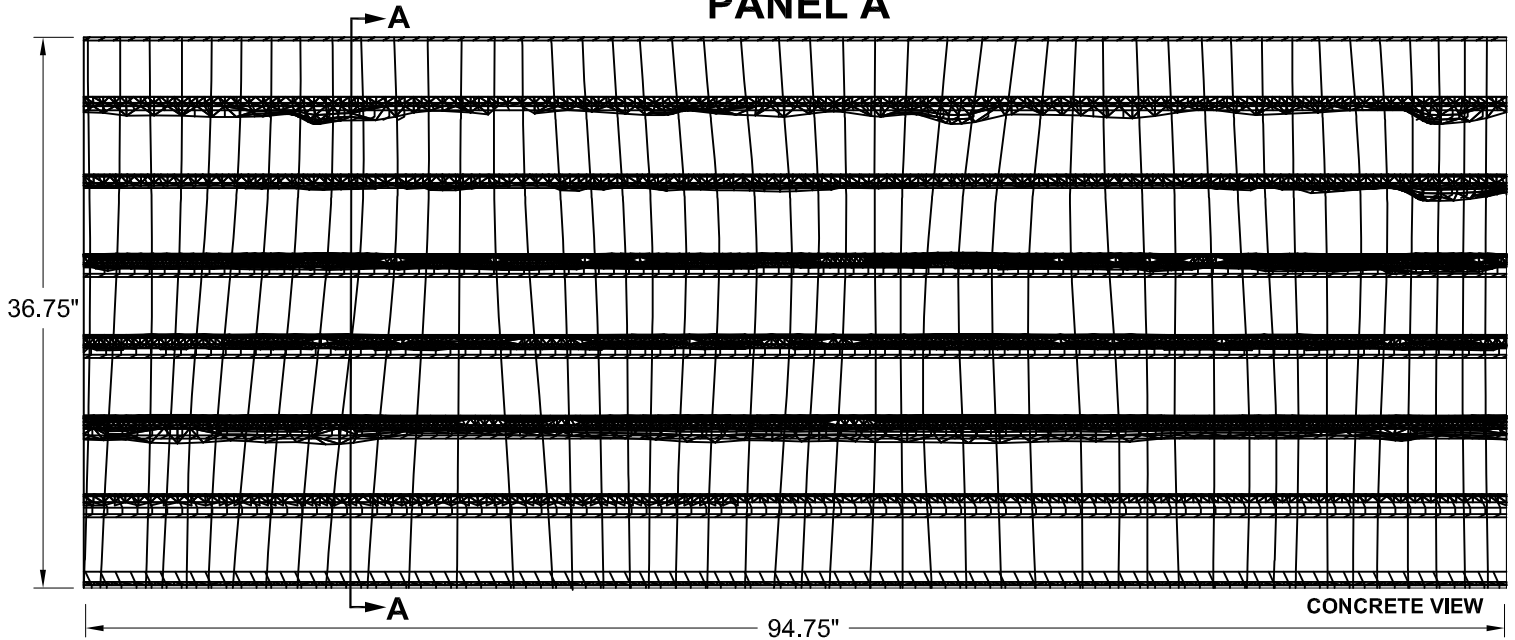

CONCRETE

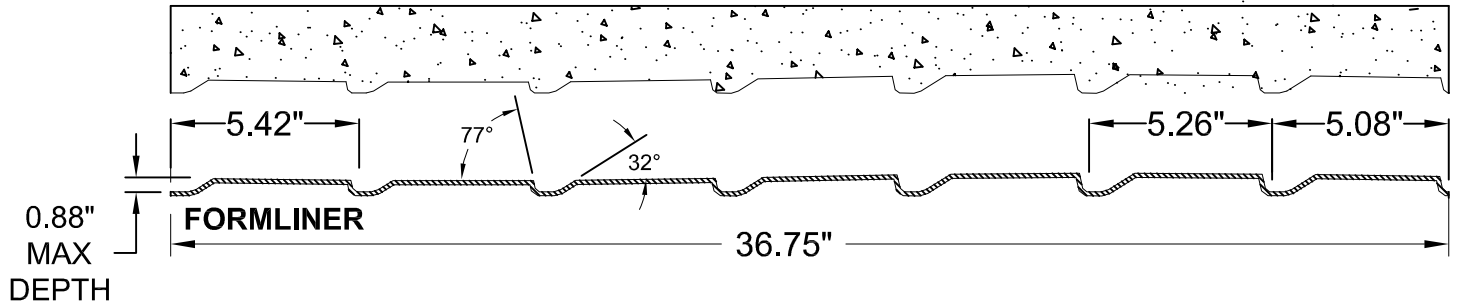

SECTION A-A

FORMLINER DETAIL

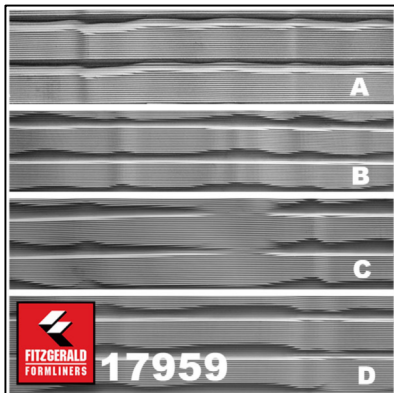

This document contains confidential and proprietary information of Fitzgerald Formliners, Inc. and is protected by copyright, trade secret, and other state and federal laws. Its receipt or possession does not cover any rights to reproduce, disclose its contents, or to manufacture, use, or sell anything it may describe. Reproduction, disclosure, or use without specific written authorization of Fitzgerald Formliners, Inc. is strictly forbidden.

FITZGERALD FORMLINERS
1500 East Chestnut Avenue • Santa Ana, CA 92701 • Fax (714) 245-9715
Ph: (800) 547-7760 • Ph (714) 547-6710 • www.formliners.com

Pattern can be requested in AutoCad format.

File Name: S-17959-VF-01-29-18

Page 1 of 5



Forming The Future™

PATTERN 17959B Los Amigos Wave

Vac-U-Form™
Styrene - Single Use.
ABS Plastic - Up to 15 reuses.

Geometric
Part Size: 94.75" W x 42" H
Max Depth: 1"

PANEL B

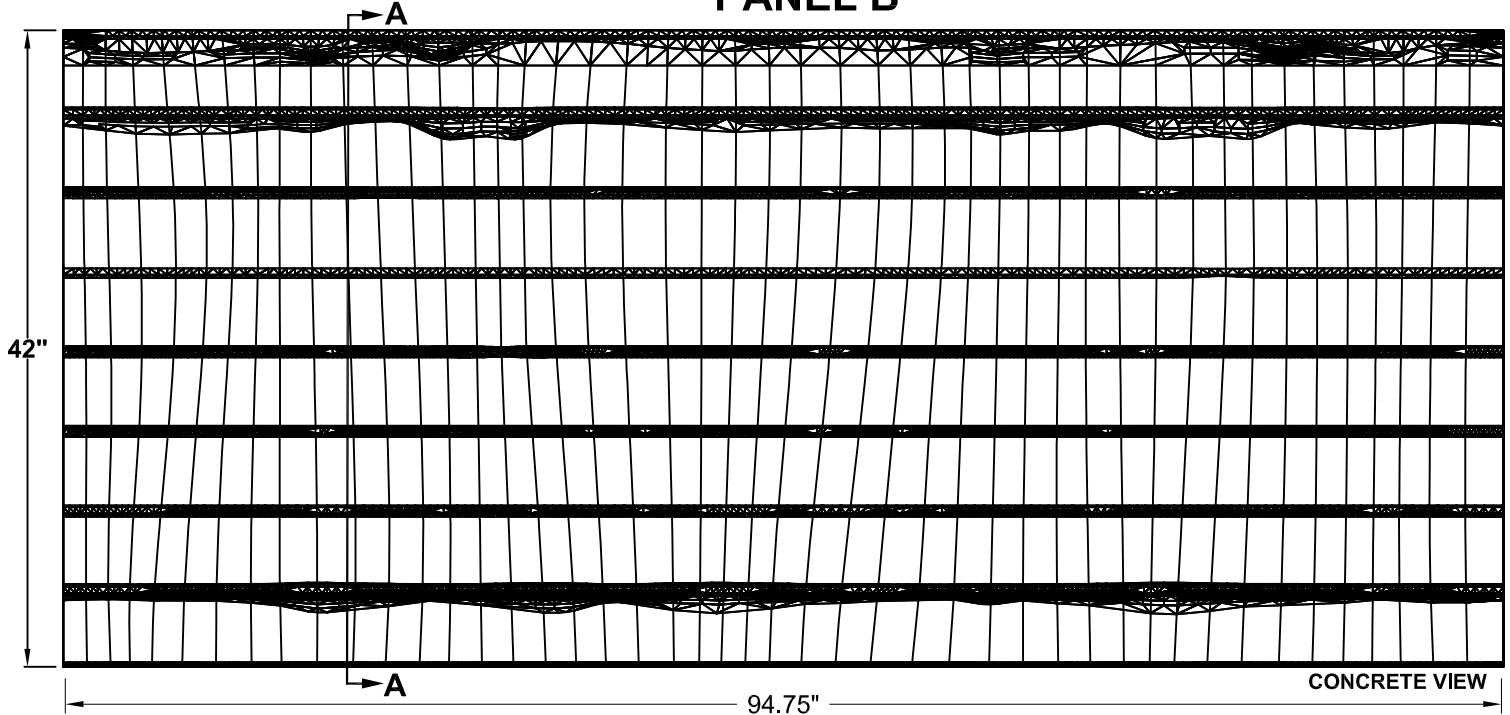

CONCRETE

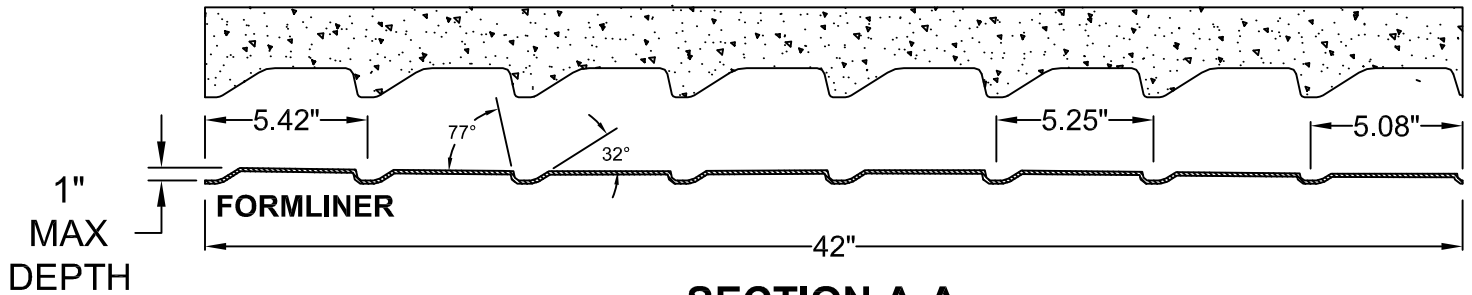

SECTION A-A FORMLINER DETAIL

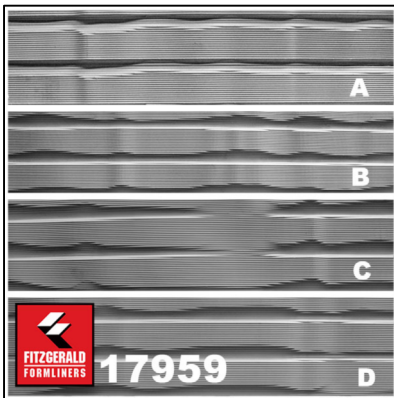

This document contains confidential and proprietary information of Fitzgerald Formliners, Inc. and is protected by copyright, trade secret, and other state and federal laws. Its receipt or possession does not cover any rights to reproduce, disclose its contents, or to manufacture, use, or sell anything it may describe. Reproduction, disclosure, or use without specific written authorization of Fitzgerald Formliners, Inc. is strictly forbidden.



Forming The Future™

PATTERN 17959C Los Amigos Wave

Vac-U-Form™
Styrene - Single Use.
ABS Plastic - Up to 15 reuses.

Geometric
Part Size: 94.75" W x 42" H
Max Depth: 1"

PANEL C

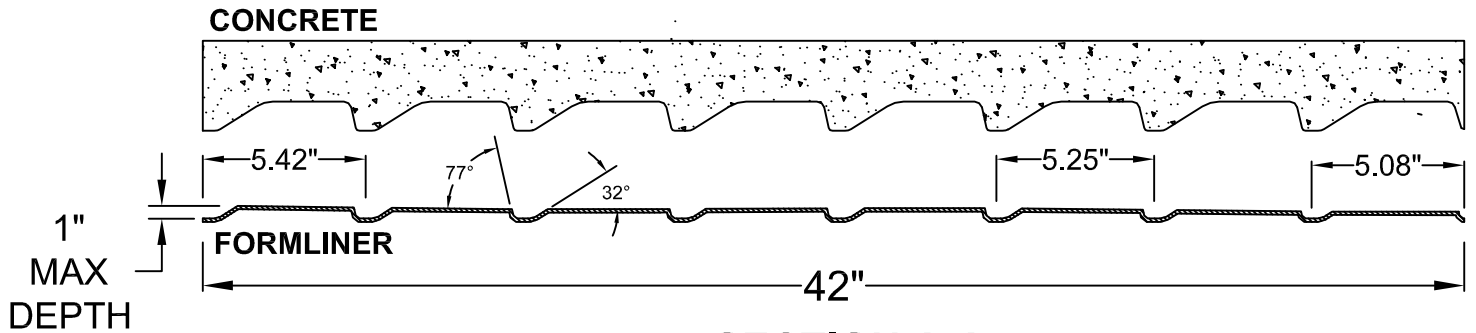
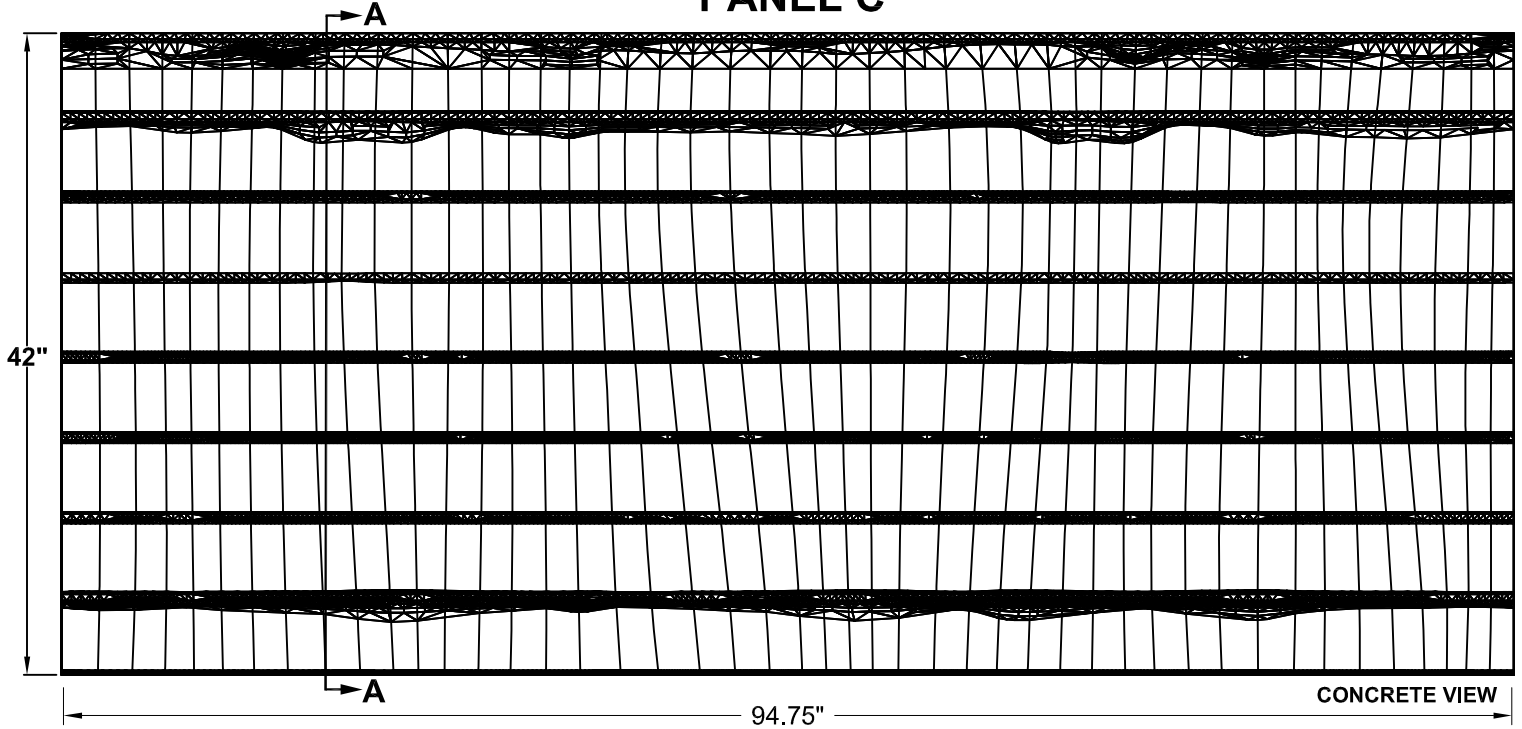

SECTION A-A FORMLINER DETAIL

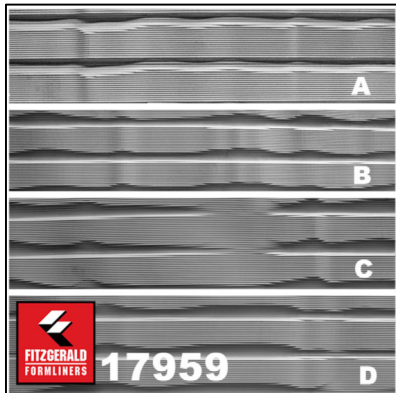

This document contains confidential and proprietary information of Fitzgerald Formliners, Inc. and is protected by copyright, trade secret, and other state and federal laws. Its receipt or possession does not cover any rights to reproduce, disclose its contents, or to manufacture, use, or sell anything it may describe. Reproduction, disclosure, or use without specific written authorization of Fitzgerald Formliners, Inc. is strictly forbidden.



Forming The Future™

PATTERN 17959D Los Amigos Wave

Vac-U-Form™

Styrene - Single Use.
ABS Plastic - Up to 15 reuses.

Geometric

Part Size: 94.75" W x 42" H

Max Depth: 1.14"

PANEL D

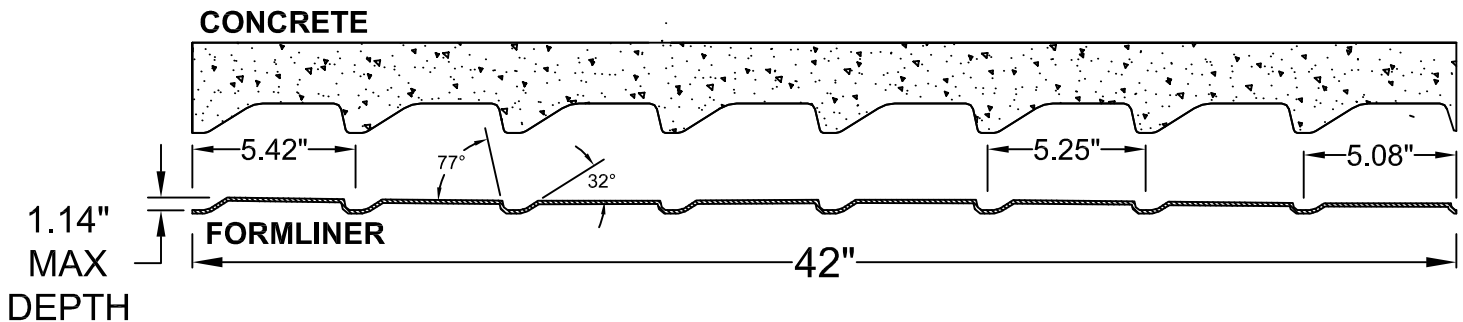
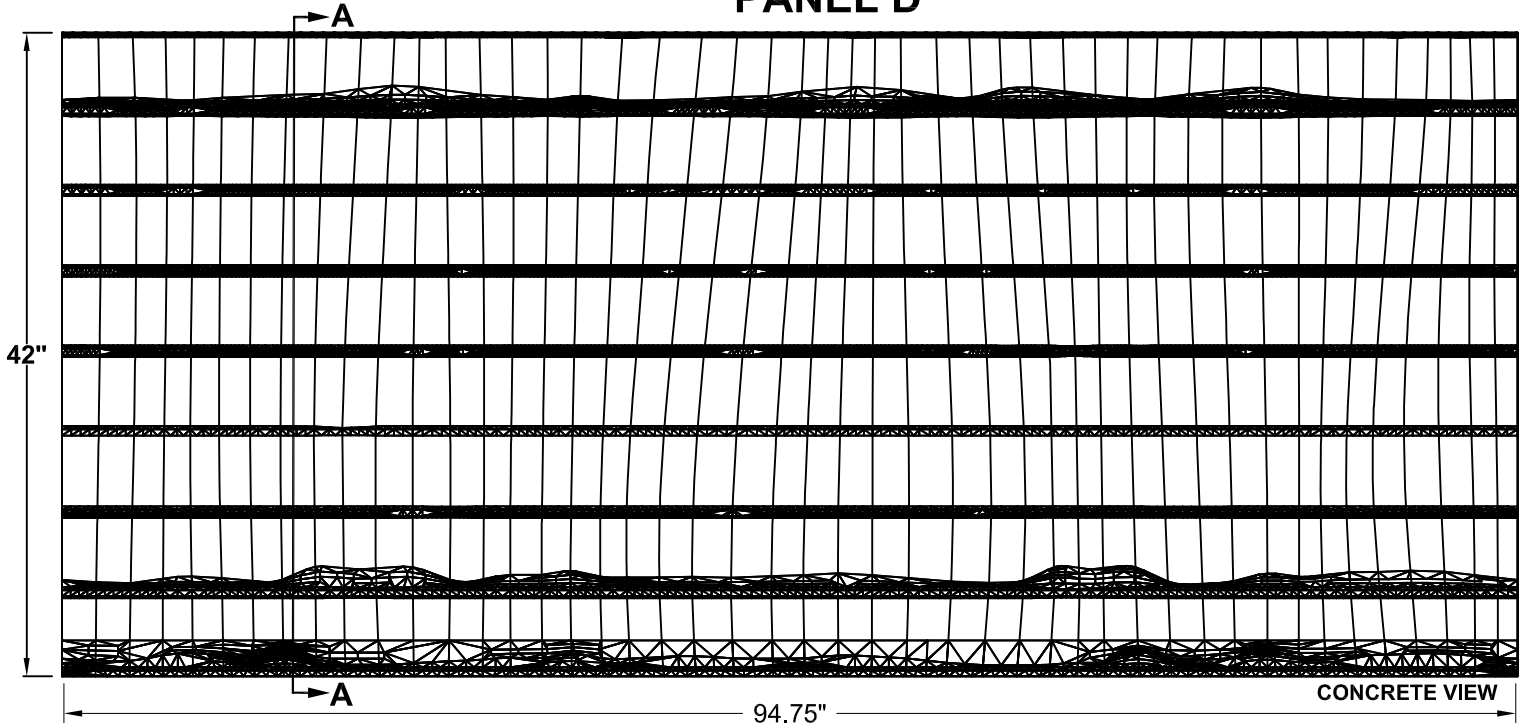

SECTION A-A

FORMLINER DETAIL

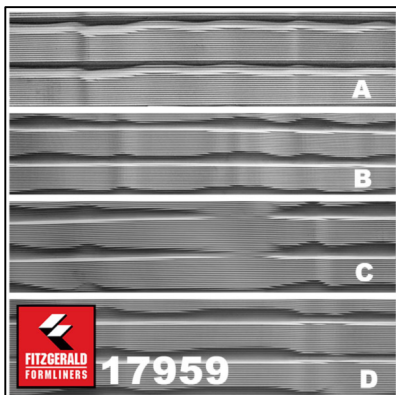

This document contains confidential and proprietary information of Fitzgerald Formliners, Inc. and is protected by copyright, trade secret, and other state and federal laws. Its receipt or possession does not cover any rights to reproduce, disclose its contents, or to manufacture, use, or sell anything it may describe. Reproduction, disclosure, or use without specific written authorization of Fitzgerald Formliners, Inc. is strictly forbidden.

FITZGERALD FORMLINERS

1500 East Chestnut Avenue • Santa Ana, CA 92701 • Fax (714) 245-9715

Ph: (800) 547-7760 • Ph (714) 547-6710 • www.formliners.com

Pattern can be requested in AutoCad format.

File Name: S-17959-VF-01-29-18

Page 4 of 5



Forming The Future™

PATTERN 17959 Los Amigos Wave

Geometric

Vac-U-Form™

Styrene - Single Use.
ABS Plastic - Up to 15 reuses.

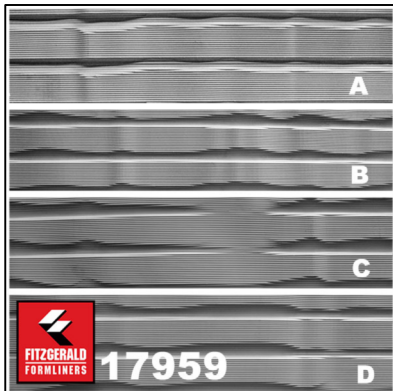
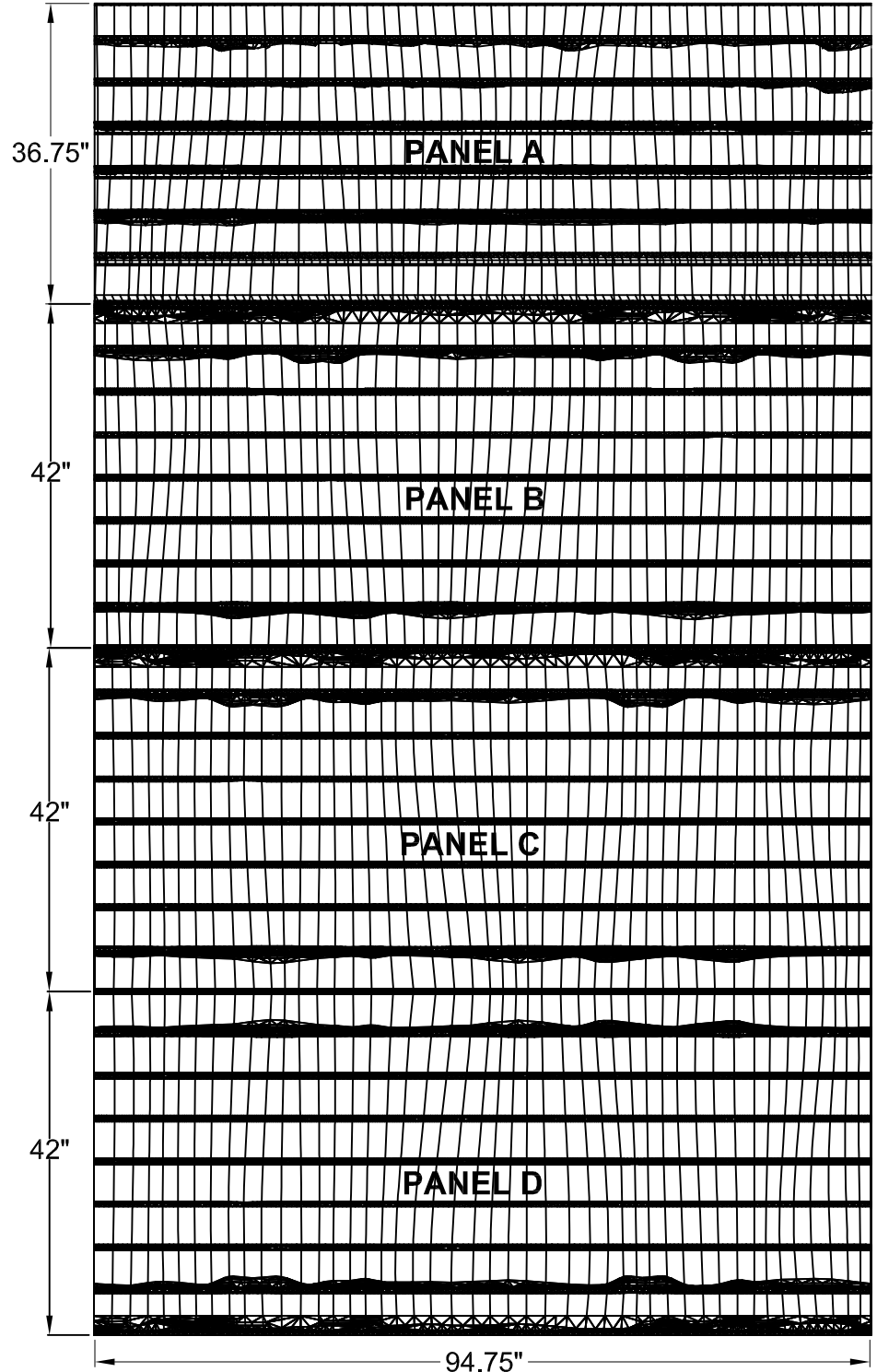

This document contains confidential and proprietary information of Fitzgerald Formliners, Inc. and is protected by copyright, trade secret, and other state and federal laws. Its receipt or possession does not cover any rights to reproduce, disclose its contents, or to manufacture, use, or sell anything it may describe. Reproduction, disclosure, or use without specific written authorization of Fitzgerald Formliners, Inc. is strictly forbidden.

FITZGERALD FORMLINERS

1500 East Chestnut Avenue • Santa Ana, CA 92701 • Fax (714) 245-9715
Ph: (800) 547-7760 • Ph (714) 547-6710 • www.formliners.com

Pattern can be requested in AutoCad format.

File Name: S-17959-VF-01-29-18

Page 5 of 5