



Forming The Future™

PATTERN 11301 - Brick Master Modular Thin Brick Gasket

R22'-8 $\frac{1}{2}$ " Arch

Single Use

Brick Master

Part Size: 45.698"W x 16.375"H (5.05 ft.²)

Max Depth: 0.25"

Brick Size: 2.25" W x 7.625" H

Mortar Joints: 0.417" Vert.
0.375" Hort.

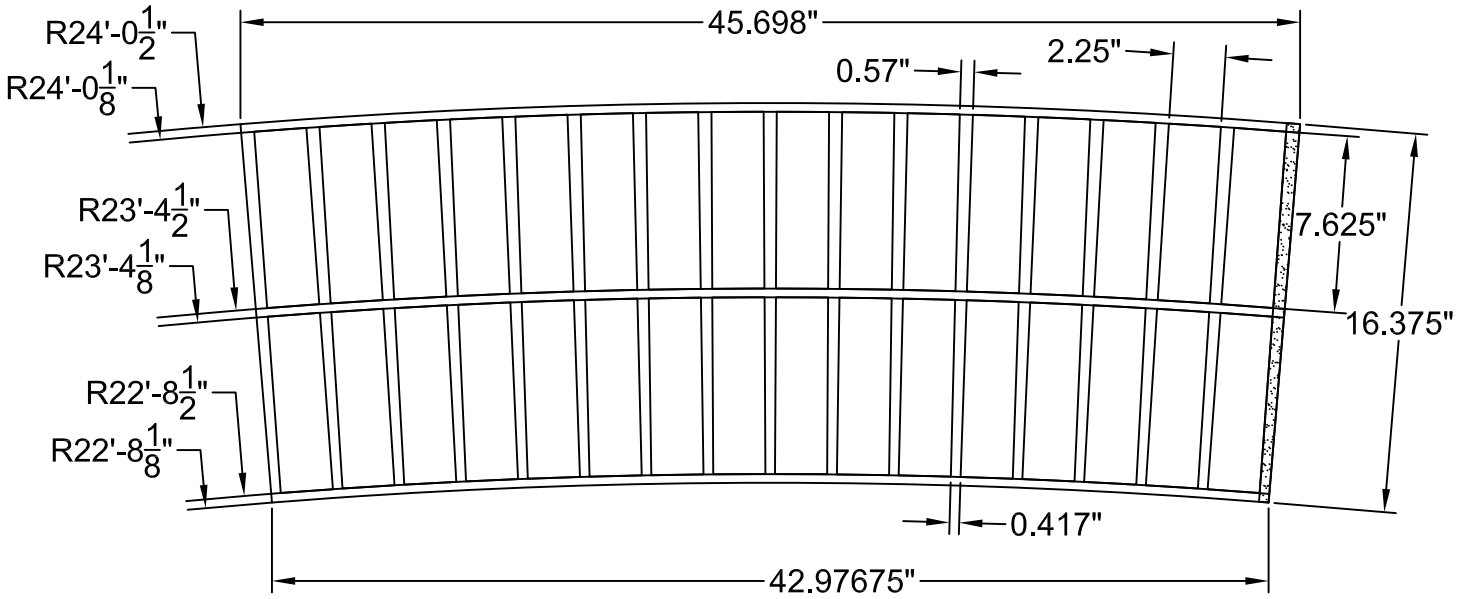

Shaded Area
for part overlay

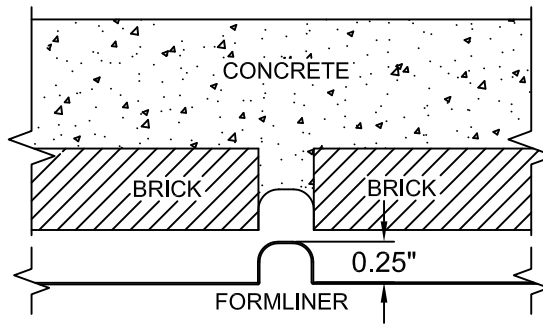

FORMLINER DETAIL

This document contains confidential and proprietary information of Fitzgerald Formliners, Inc. and is protected by copyright, trade secret, and other state and federal laws. Its receipt or possession does not cover any rights to reproduce, disclose its contents, or to manufacture, use, or sell anything it may describe. Reproduction, disclosure, or use without specific written authorization of Fitzgerald Formliners, Inc. is strictly forbidden.

FITZGERALD FORMLINERS

1500 East Chestnut Avenue • Santa Ana, CA 92701 • Fax (714) 245-9715

Ph: (800) 547-7760 • Ph (714) 547-6710 • www.formliners.com

Pattern can be requested in AutoCad format.

File Name: S-301R22-8-VF-1-7-09

Page 1 of 1